

TECHNICAL DATA

Three Phase Electric Motors - Cast Iron Frame
 PE30 225 M 6 IE3
 30 kW / 40 Cv
 985 RPM

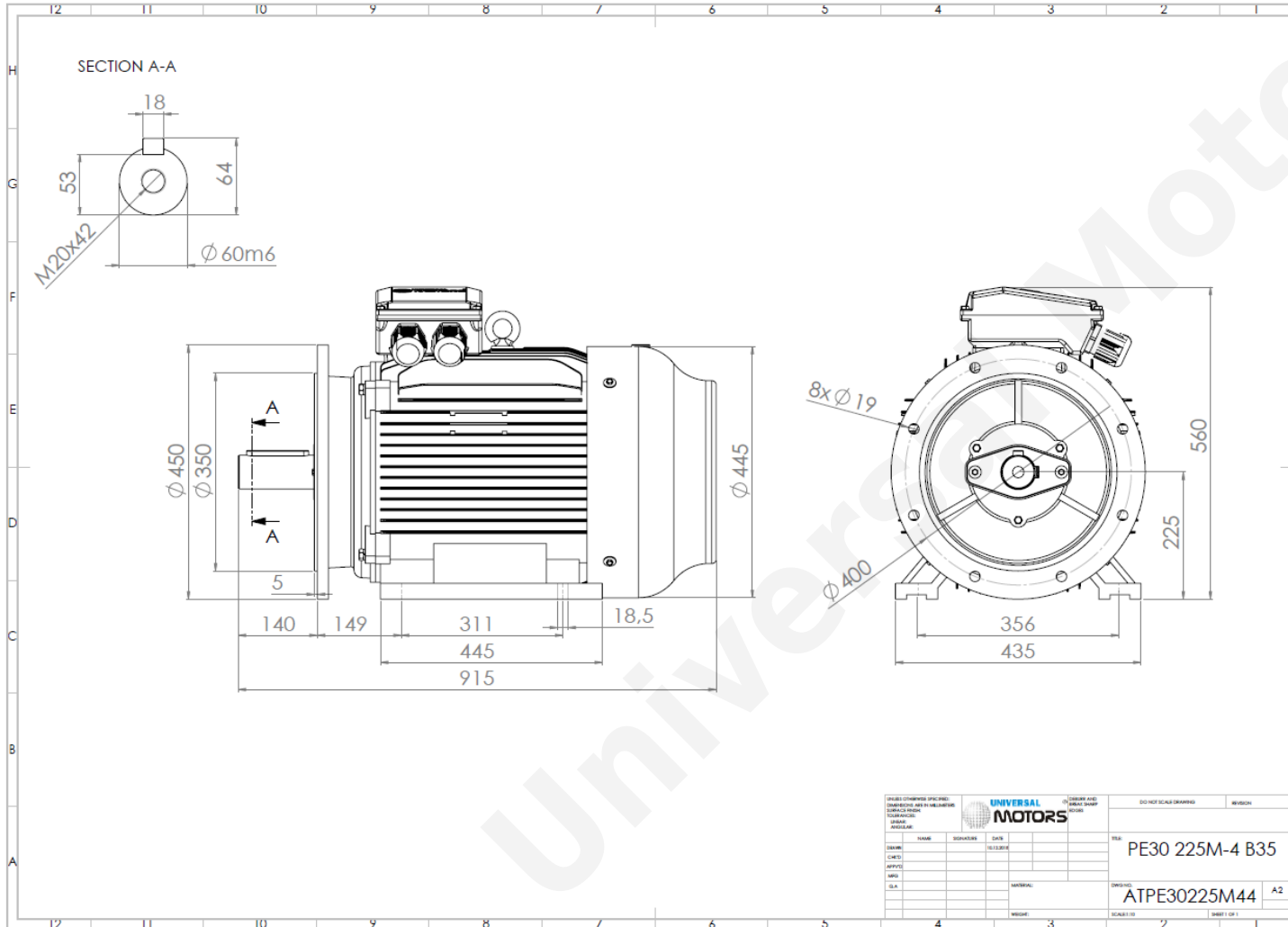

Motor type:	PE30 225 M 6 IE3
Output:	30 kW / 40 Cv
Speed (min ⁻¹):	985 RPM
Frequency:	50 Hz
Voltage:	400 V
Current:	56.2 A
Power factor (Cos \varnothing):	0.83
Poles:	6
Insulation class:	F
Temperature rise Class:	B
Efficiency 50%:	92.2 %
Efficiency 75%:	93.2 %
Efficiency 100%:	92.9 %
Torque:	291 N.m
Tstarting/Tnominal:	2.0
Istarting/Inominal:	6.9
Tmaximum/Tnominal:	2.1
Noise:	65 Db(A)
Weight:	392 Kg
Bearing DE:	6313 C3
Bearing NDE:	6313 C3

Regime - S1

Altitude - 1000m

Environment Temperature - 40°C

CONTACTS:

UNIVERSAL MOTORS Tel: +351 252 299 080
 Rua de São Brás,745 Fax: +351 252 299 089
 4480-782 VILA DO CONDE Mail: geral@universalmotors.pt

* References applied only in the UK